

KALIA INDUSTRIES

AN ISO 9001:2015,14001:2015,OHSAS189001:2007 AND BIFMA CERTIFIED COMPANY

B 27 AMANPURI, NAJAFGARH ROAD, NANGLOI

NEW DELHI-110041

MOB NO. 9811208456 , 9315223929

Dated: 21st December 2021

Award Letter for Consultancy Project on "Smart furniture designs and details including 3D renderings, plans elevation and side views"

Dear Dr. Saurav Dixit

K R Mangalam University

Gurugram Sohna Road

Haryana

Please refer to your discussion related to Consultancy Project on "Smart furniture designs and details including 3D renderings, plans elevation and side views", we are pleased to inform you that the management of our company has approved the said project and has sanction amount of Rs. 8,00,000/- (Rs. Eight Lakh only) towards the project implementation cost payable to your organisation "K R Mangalam University".

The main PI for the project is Prof (Dr) Saurav Dixit, PhD.

You are requested to submit the final report along with design and drawings of rendering of the said project.

Regards

For Kalia Industries

KALIA INDUSTRIES
B-27, Amanpuri, Najafgarh Road,
Nangloi, New Delhi-110041
GSTIN-07BEPPK8310H1ZC



Registrar
K.R. Mangalam University
Sohna Road, Gurugram, (Haryana)

SMART FURNITURE DESIGNS AND DETAILS INCLUDING 3D RENDERINGS, PLANS ELEVATION AND SIDE VIEWS

Introduction: Smart furniture is an important component of smart city. This type of furniture requires analysis of space and user as it has to be designed according to that. Furniture that can be modified easily according to the use can come under smart furniture category for example foldable couch, chairs, beds etc. multi-purpose furniture are also a part of the smart furniture category. For example, convertible couch, bed, table etc.

Advantages:

1. It saves space as it is foldable.
2. It is Aesthetically more pleasing as we can choose the color and texture as per our choice.
3. It is Customizable
4. Multi-purpose as it has more than one use.

Concept design and drawings:

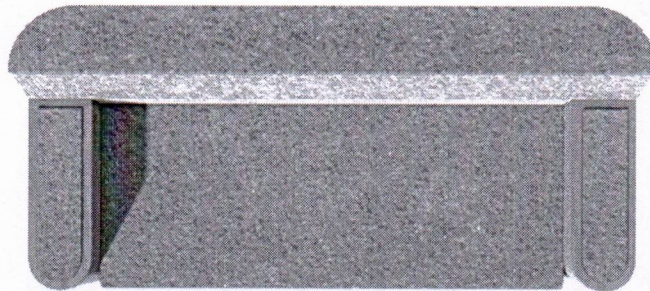

Plan stage 1

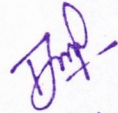
Registrar
K.R. Mangalam University
Sohna Road, Gurugram, (Haryana)

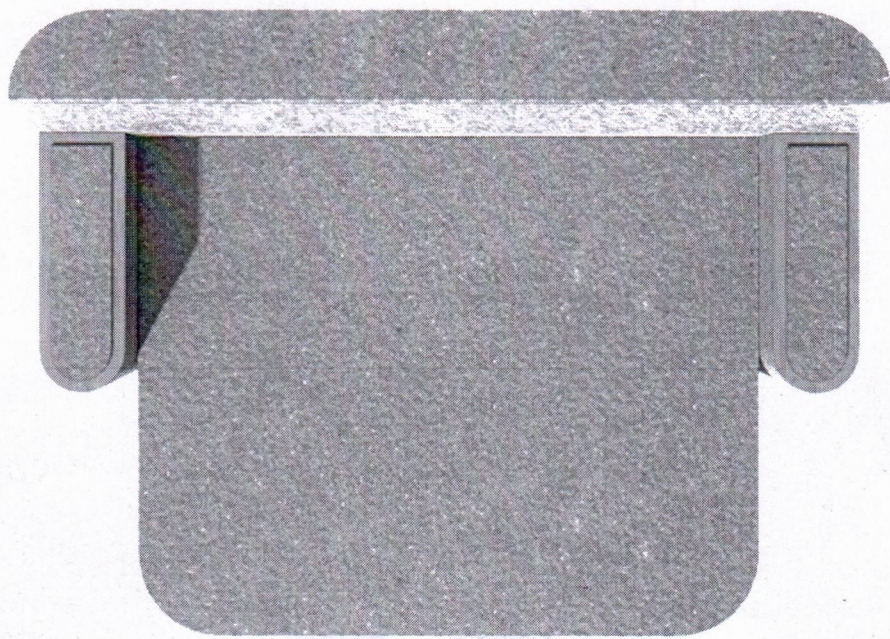

Plan stage 2

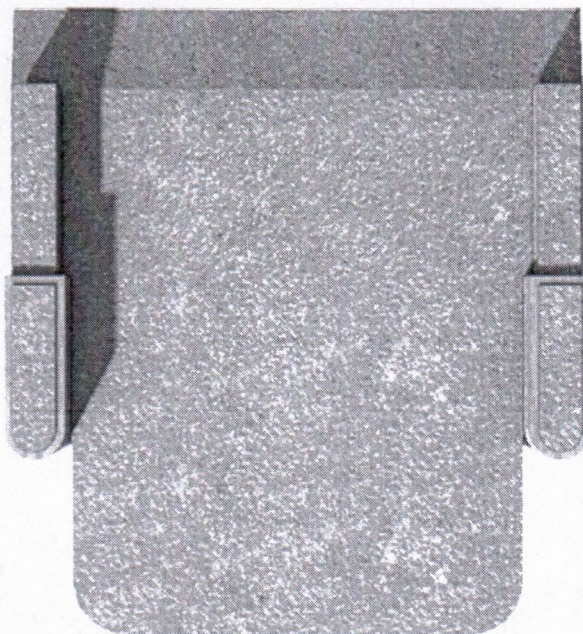

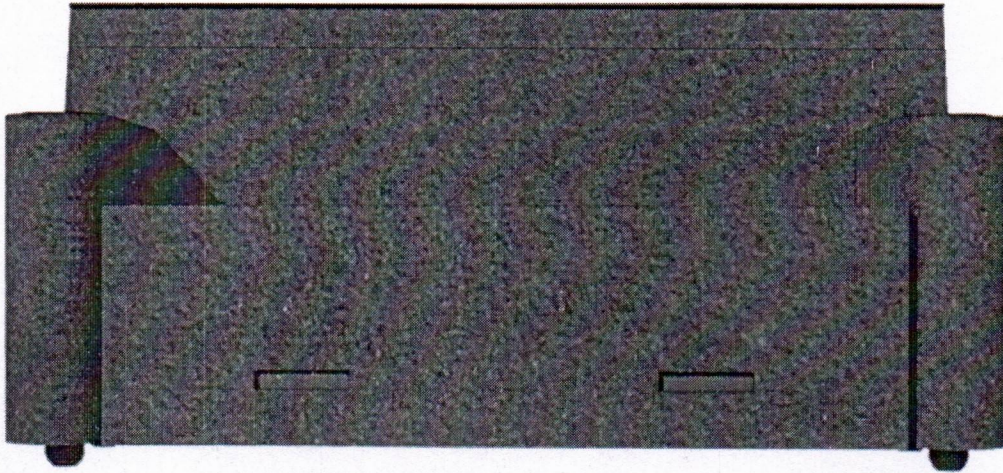

Registrar
K.R. Mangalam University
Sohna Road, Gurugram, (Haryana)

Plan stage 3

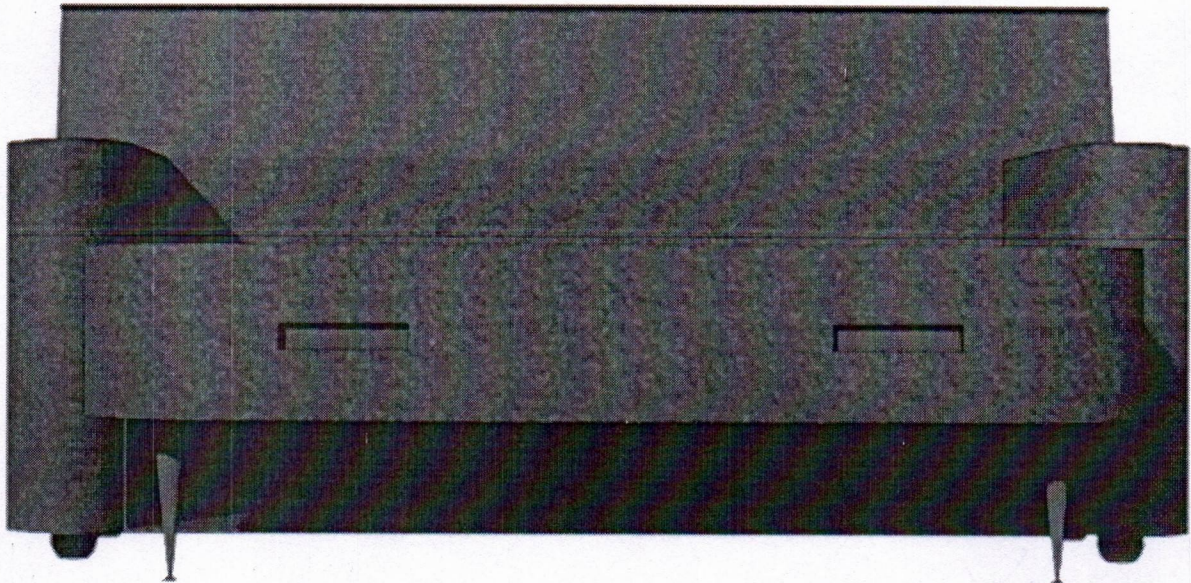

Elevation stage 1



JMP

Registrar
K.R. Mangalam University
Sohna Road, Gurugram, (Haryana)

Elevation stage 2

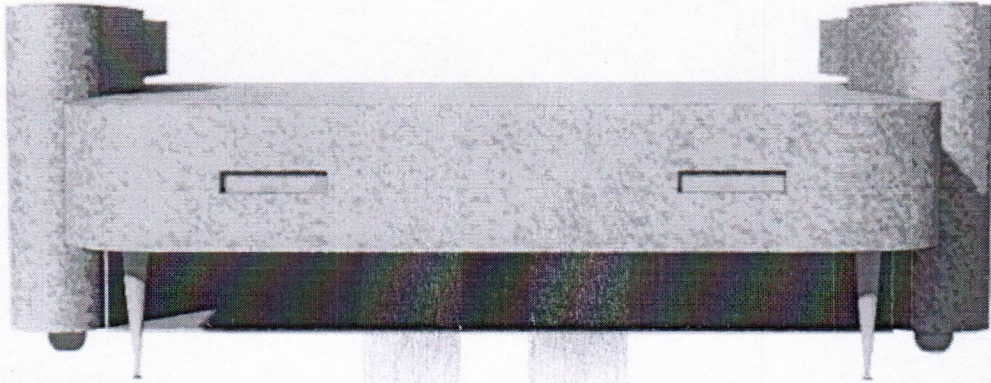

Elevation stage 3

Registrar
K.R. Mangalam University
Sohna Road, Gurugram, (Haryana)

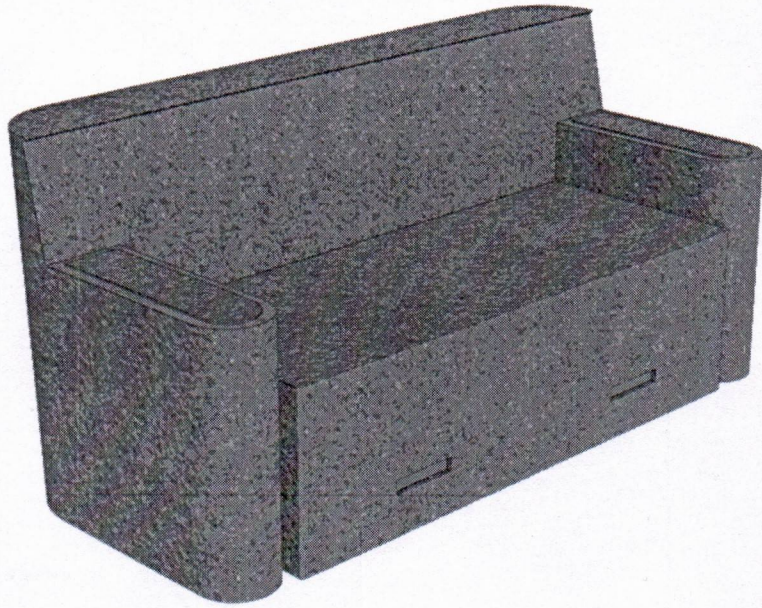

Isometric view stage 1

Registrar
K.R. Mangalam University
Sohna Road, Gurugram, (Haryana)

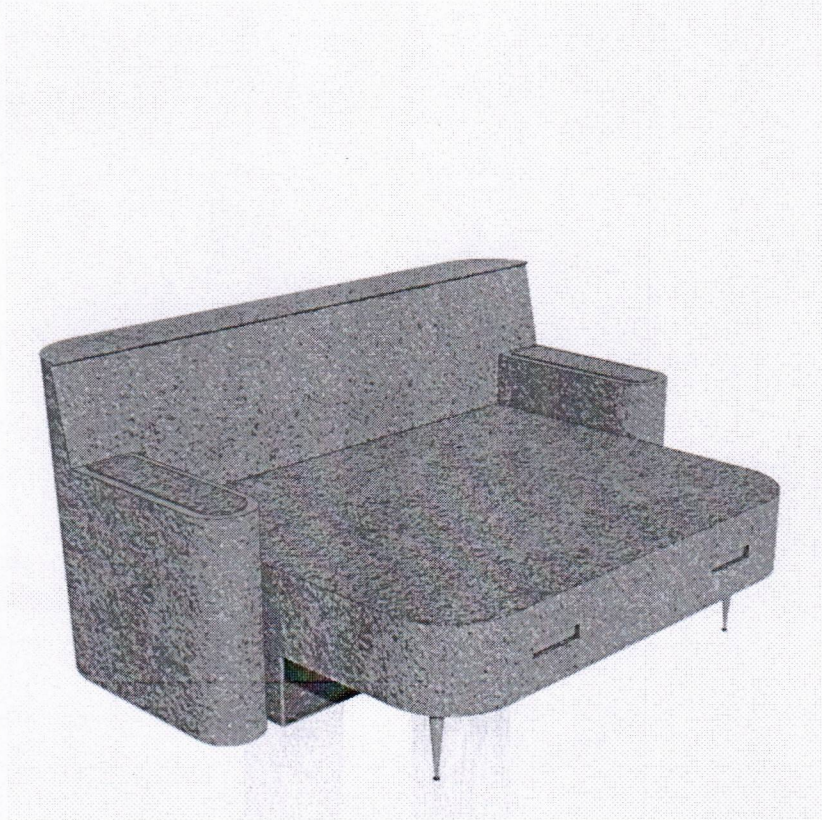

Isometric view stage 2

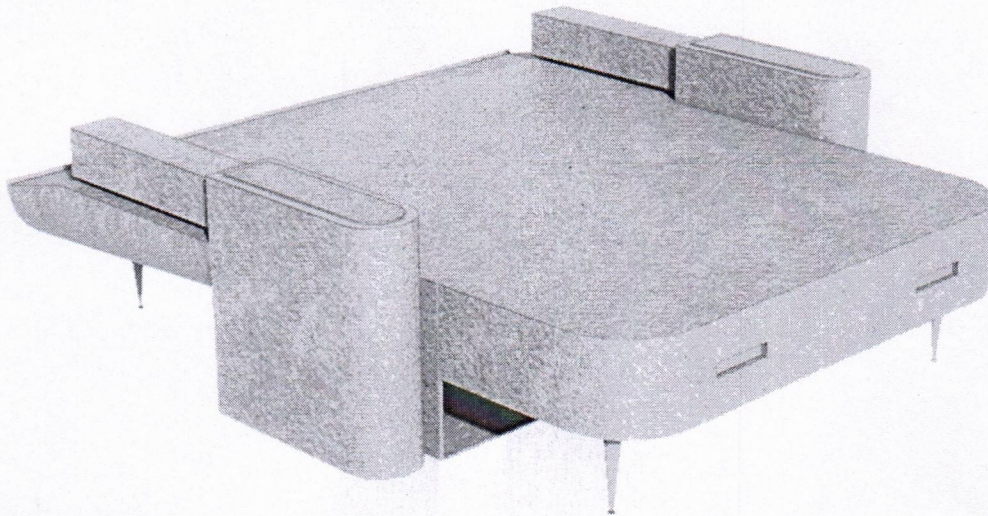

Isometric view stage 3

Registrar
K.R. Mangalam University
Sohna Road, Gurugram, (Haryana)

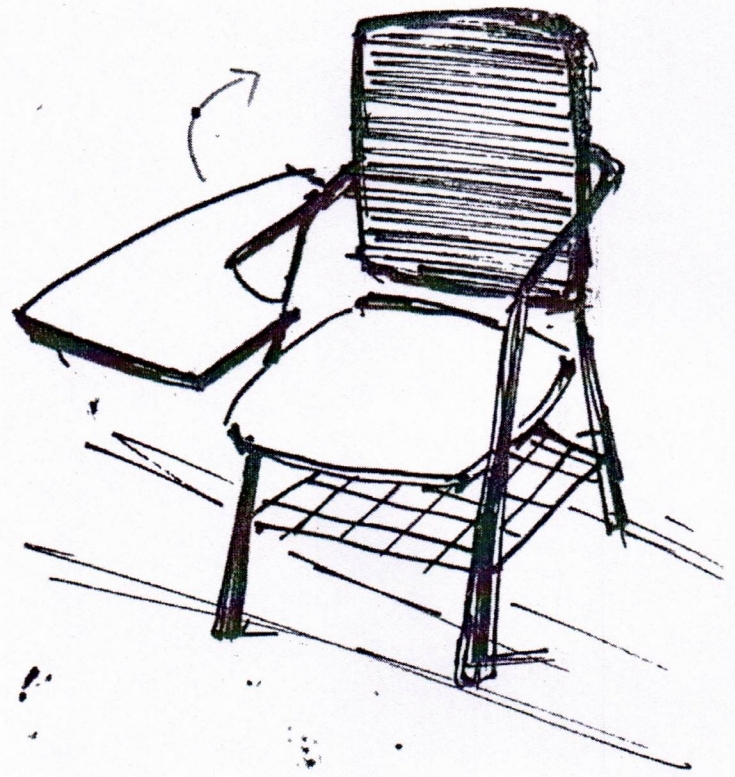
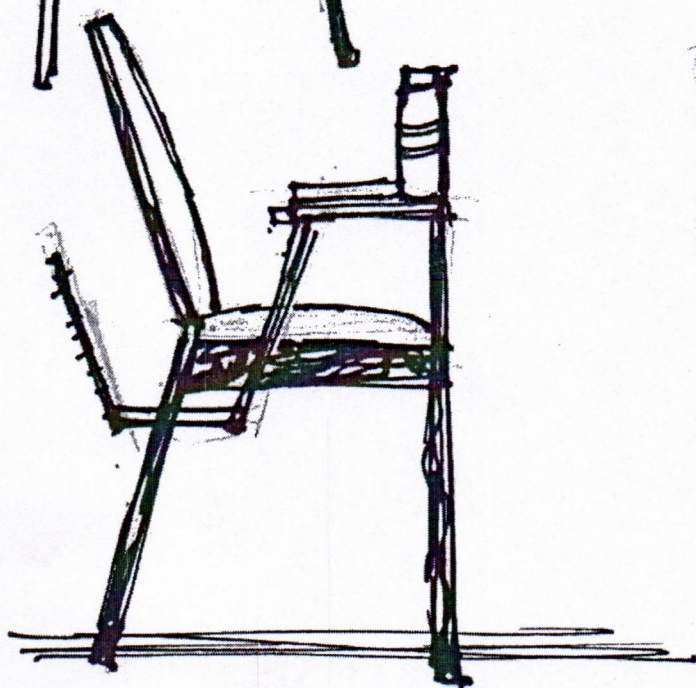
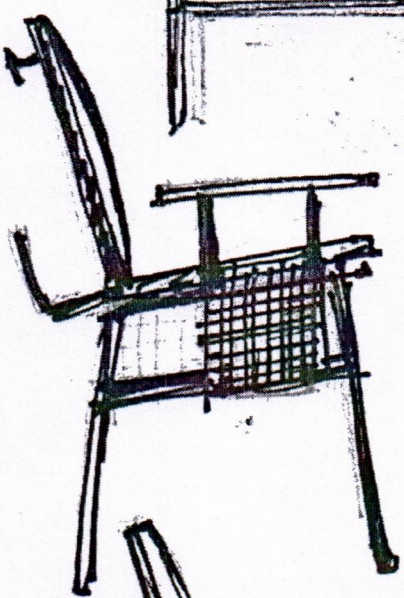
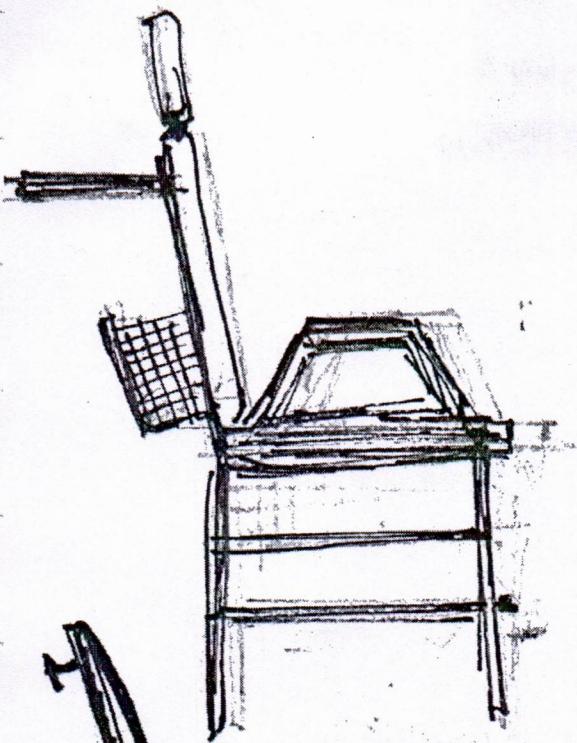

JmD
Registrar
K.R. Mangalam University
Sohna Road, Gurugram, (Haryana)

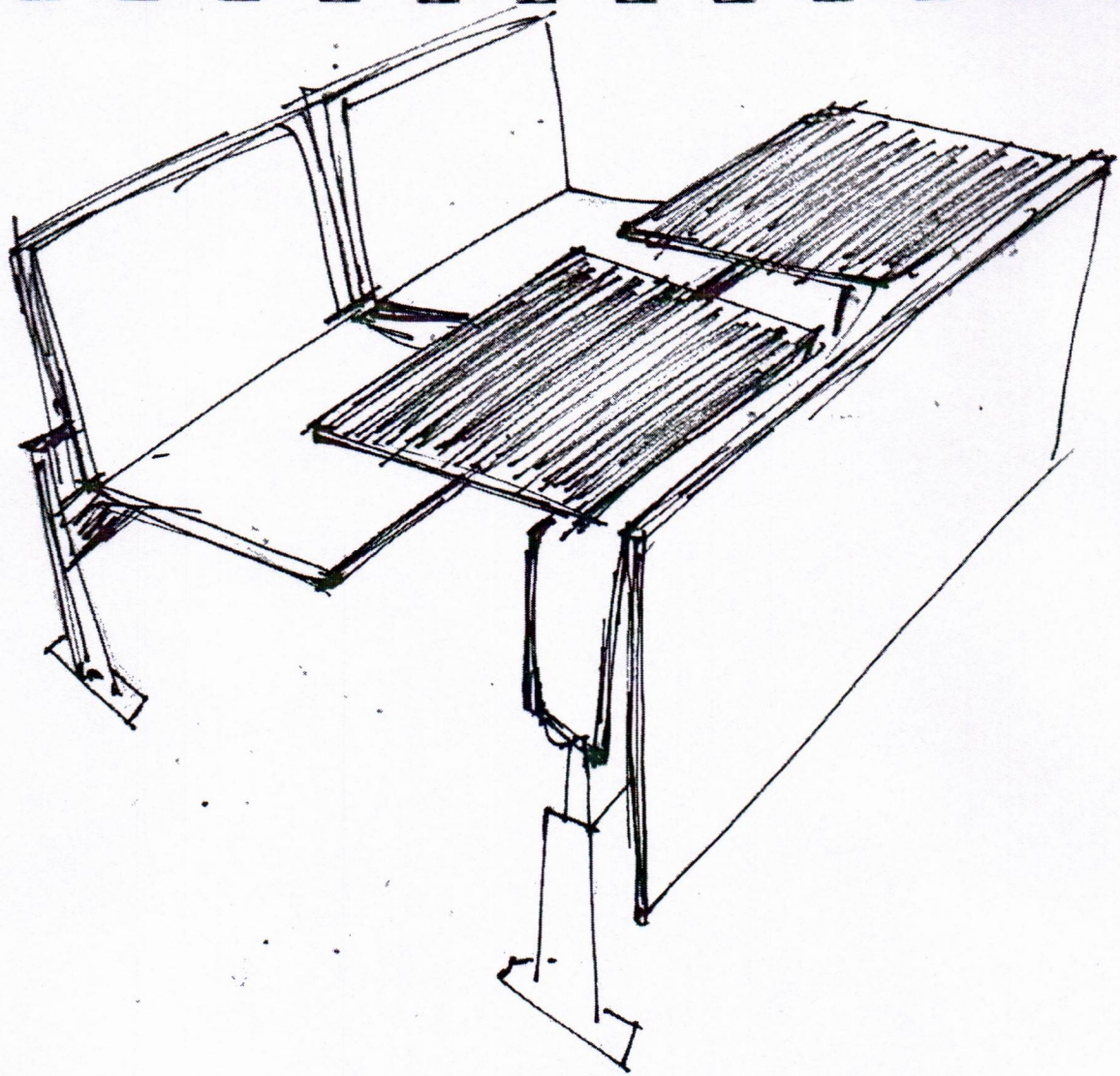

Jmd

Registrar
K.R. Mangalam University
Sehna Road, Gurugram, (Haryana)

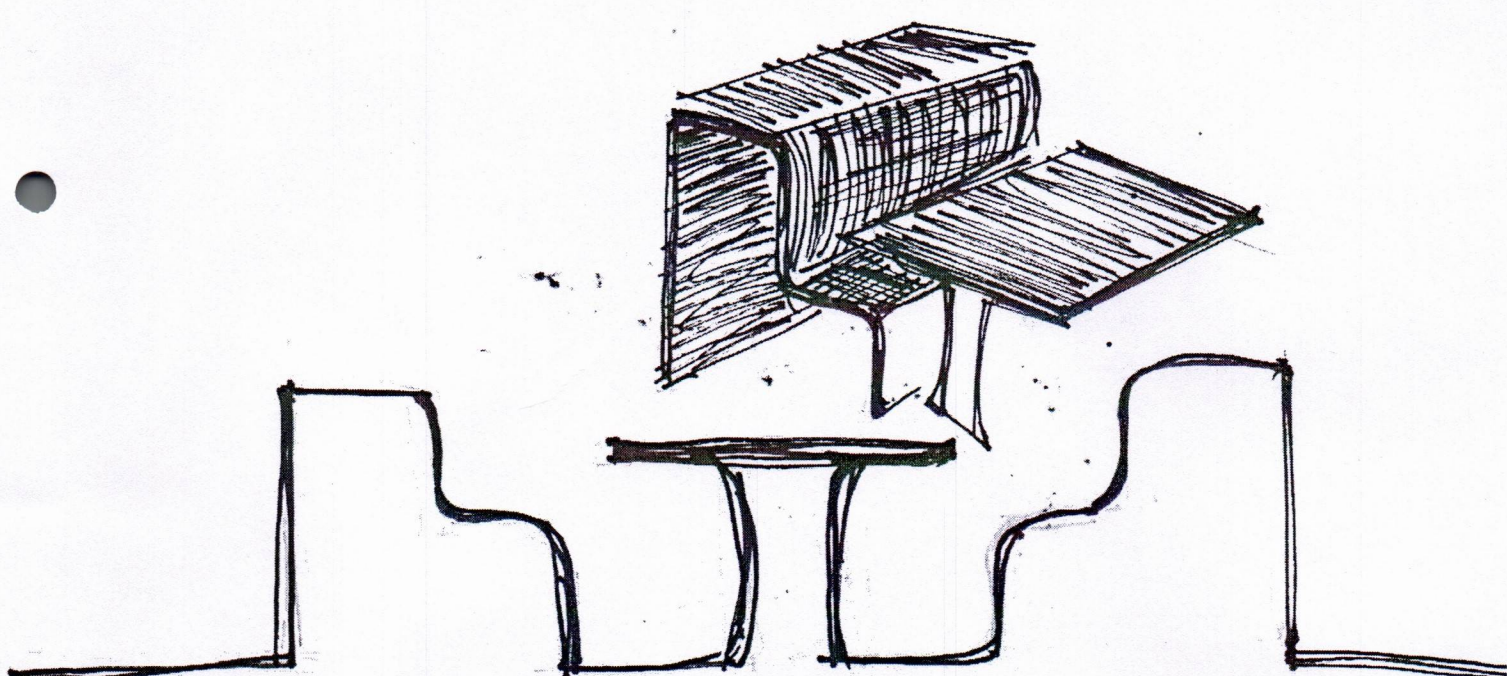

Jmd
Registrar
K.R. Mangalam University
Sohna Road, Gurugram, (Haryana)

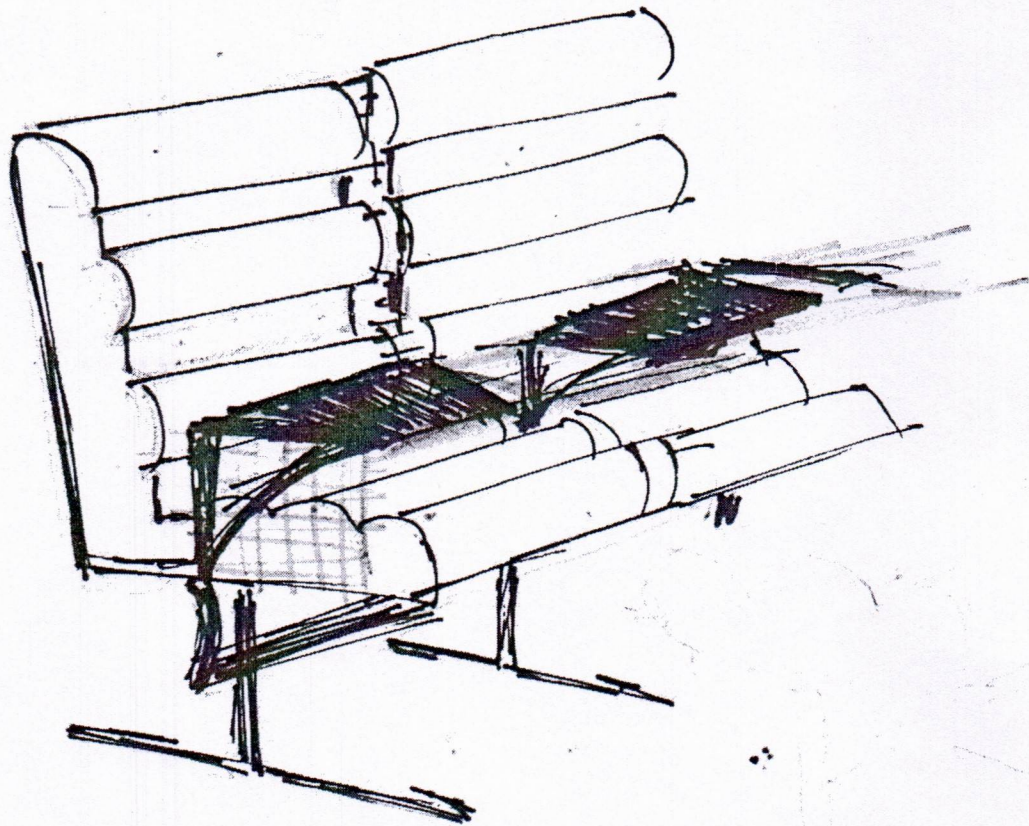

Jyoti

Registrar
K.R. Mangalam University
Sohna Road, Gurugram, (Haryana)

Re: Consultancy project proposal: Smart furniture

Dr. Saurav Dixit <saurav.dixit@krmangalam.edu.in>

Wed 22-Dec-21 10:39 AM

To: Brijesh Kalia <kaliachairs@gmail.com>

📎 2 attachments (7 MB)

Smart furniture designs and details including 3D renderings (1).docx; Chair Design sketches. (1).pdf;

Dear Sir,

Greetings!!!

PFA herewith the final report for "Smart furniture designs and details including 3d renderings, plans elevation and side views" for your review and approval.

Looking forward to hearing from you soon.

Best regards,

Dr. Saurav Dixit, PhD

Associate Dean Research and Director International Collaboration

M +919289021467; t +9101242867800 (extension-1046)

e- saurav.dixit@krmangalam.edu.in

Editorial Board Member at Construction of Unique Buildings and Structures, St. Petersburg

https://unistroy.spbstu.ru/en/editorial_board/

Scopus ID: 57194779967; <https://www.scopus.com/authid/detail.uri?authorId=57194779967>

ORCID: <http://orcid.org/0000-0002-6959-0008>

ResearchGate: https://www.researchgate.net/profile/Saurav_Dixit

Google Scholar: <https://scholar.google.com/citations?user=uTmnqJIAAAAJ&hl=en>

Publons: <https://scholar.google.com/citations?user=uTmnqJIAAAAJ&hl=en>

K. R. Mangalam University, Sohna Road, Gurgaon, India, 122103

<https://www.krmangalam.edu.in>



K.R. MANGALAM UNIVERSITY
THE COMPLETE WORLD OF EDUCATION

From: Brijesh Kalia <kaliachairs@gmail.com>

Sent: Tuesday, December 21, 2021 1:25 PM

To: Dr. Saurav Dixit <saurav.dixit@krmangalam.edu.in>

Subject: Re: Consultancy project proposal: Smart furniture

Registrar
K.R. Mangalam University
Sohna Road, Gurugram, (Haryana)

Dear Dr. Saurav Dixit
K R Mangalam University
Gurugram Sohna Road
Haryana

Please refer to your discussion related to Consultancy Project on "Smart furniture designs and details including 3D renderings, plans elevation and side views", we are pleased to inform you that the management of our company has approved the said project and has sanction amount of Rs. 8,00,000/- (Rs. Eight Lakh only) towards the project implementation cost payable to your organisation "K R Mangalam University".

The main PI for the project is Prof (Dr) Saurav Dixit, PhD.

You are requested to submit the final report along with design and drawings of rendering of the said project.

Regards

On Sat, Dec 18, 2021, 9:53 AM Dr. Saurav Dixit <saurav.dixit@krmangalam.edu.in> wrote:

Dear Sir,

Greetings!!

Thank you very much for sparing your valuable time to attend the meeting yesterday at our University Sohna road, Gurgaon. It was a pleasure meeting you, discussing the plan, and presenting the ideas and sketches for your new furniture products.

PFA herewith the draft sketches for your kind perusal and approval.
The cost of the consultancy project would be 800k.

We will be sharing the final drawings for smart furniture by Tuesday 21st December 2021.

Looking forward to hearing from you soon.
Best regards,

Dr. Saurav Dixit, PhD

Associate Dean Research and Director International Collaboration

M +919289021467; t +9101242867800 (extension-1046)

e- saurav.dixit@krmangalam.edu.in

Editorial Board Member at Construction of Unique Buildings and Structures, St. Petersburg

https://unistroy.spbstu.ru/en/editorial_board/

Registrar
K.R. Mangalam University
Sohna Road, Gurugram, (Haryana)

Scopus ID: 57194779967; <https://www.scopus.com/authid/detail.uri?authorId=57194779967>

ORCID: <http://orcid.org/0000-0002-6959-0008>

ResearchGate: https://www.researchgate.net/profile/Saurav_Dixit

Google Scholar: <https://scholar.google.com/citations?user=uTmnqJIAAAAJ&hl=en>

Publons: <https://scholar.google.com/citations?user=uTmnqJIAAAAJ&hl=en>

K. R. Mangalam University, Sohna Road, Gurgaon, India, 122103

<https://www.krmangalam.edu.in>



From: Brijesh Kalia <kaliachairs@gmail.com>

Sent: Friday, December 17, 2021 1:35 PM

To: Dr. Saurav Dixit <saurav.dixit@krmangalam.edu.in>

Subject: Re: Consultancy project proposal: Smart furniture

Dear sir

Greetings from Kalia industries!!

Sir we will come and discuss with you at your place .

Regards

On Thu, Dec 16, 2021, 5:31 PM Dr. Saurav Dixit <saurav.dixit@krmangalam.edu.in> wrote:

Dear sir,

Greetings of the day, I hope this email finds you in good health!!

I Dr Saurav Dixit, currently working as Dean R & D at K. R. Mangalam University, Gurgaon, India.

I am contacting you for a consultancy project proposal "Smart furniture" as per our discussion over phone. We have an effective and dynamic team of professionals and researchers who have previously worked on feasibility study projects, provided training and consulting services to industry, and collaborated on national and international research and consulting initiatives.

We would like to propose consultancy project titled " Smart furniture designs and details" for your firm.

Kindly spare 15-20 minutes to discuss this further in detail as per your convenience.

Looking forward to hearing from you.

Thankfully,

Best regards,

Dr. Saurav Dixit, PhD

Associate Dean Research and Director International Collaboration

M +919289021467; t +9101242867800 (extension-1046)

e- saurav.dixit@krmangalam.edu.in

Registrar
K.R. Mangalam University
Sohna Road, Gurugram, (Haryana)

Editorial Board Member at Construction of Unique Buildings and Structures, St. Petersburg

https://unistroy.spbstu.ru/en/editorial_board/

Scopus ID: 57194779967; <https://www.scopus.com/authid/detail.uri?authorId=57194779967>

ORCID: <http://orcid.org/0000-0002-6959-0008>

ResearchGate: https://www.researchgate.net/profile/Saurav_Dixit

Google Scholar: <https://scholar.google.com/citations?user=uTmnqJIAAAAJ&hl=en>

Publons: <https://scholar.google.com/citations?user=uTmnqJIAAAAJ&hl=en>

K. R. Mangalam University, Sohna Road, Gurgaon, India, 122103

<https://www.krmangalam.edu.in>



Disclaimer: Please do not print this email unless it is absolutely necessary. The information contained in this electronic message and any attachments to this message are intended for the exclusive use of the addressee(s) and may contain proprietary, confidential or privileged information. If you are not the intended recipient, you should not disseminate, distribute or copy this e-mail. Please notify the sender immediately and destroy all copies of this message and any attachments. The content and the items accessible from the email are the sole responsibility of their creators and do not represent positions, policies, or opinions of the organization. Forward the mail to tech@krmangalam.edu.in or visit www.krmangalam.edu.in

Disclaimer: Please do not print this email unless it is absolutely necessary. The information contained in this electronic message and any attachments to this message are intended for the exclusive use of the addressee(s) and may contain proprietary, confidential or privileged information. If you are not the intended recipient, you should not disseminate, distribute or copy this e-mail. Please notify the sender immediately and destroy all copies of this message and any attachments. The content and the items accessible from the email are the sole responsibility of their creators and do not represent positions, policies, or opinions of the organization. Forward the mail to tech@krmangalam.edu.in or visit www.krmangalam.edu.in

Disclaimer: Please do not print this email unless it is absolutely necessary. The information contained in this electronic message and any attachments to this message are intended for the exclusive use of the addressee(s) and may contain proprietary, confidential or privileged information. If you are not the intended recipient, you should not disseminate, distribute or copy this e-mail. Please notify the sender immediately and destroy all copies of this message and any attachments. The content and the items accessible from the email are the sole responsibility of their creators and do not represent positions, policies, or opinions of the organization. Forward the mail to tech@krmangalam.edu.in or visit www.krmangalam.edu.in

Disclaimer: Please do not print this email unless it is absolutely necessary. The information contained in this electronic message and any attachments to this message are intended for the exclusive use of the addressee(s) and may contain proprietary, confidential or privileged information. If you are not the intended recipient, you should not disseminate, distribute or copy this e-mail. Please notify the sender immediately and destroy all copies of this message and any attachments. The content and the items accessible from the email are the sole responsibility of their creators and do not represent positions, policies, or opinions of the organization. Forward the mail to tech@krmangalam.edu.in or visit www.krmangalam.edu.in

Disclaimer: Please do not print this email unless it is absolutely necessary. The information contained in this electronic message and any attachments to this message are intended for the exclusive use of the addressee(s) and may contain proprietary, confidential or privileged information. If you are not the intended recipient, you should not disseminate, distribute or copy

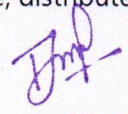
Registrar
K.R. Mangalam University
Sohna Road, Gurugram, (Haryana)

this e-mail. Please notify the sender immediately and destroy all copies of this message and any attachments. The content and the items accessible from the email are the sole responsibility of their creators and do not represent positions, policies, or opinions of the organization. Forward the mail to tech@krmangalam.edu.in or visit www.krmangalam.edu.in

Registrar
K.R. Mangalam University
Sohna Road, Gurugram, (Haryana)



K.R. MANGALAM UNIVERSITY
THE COMPLETE WORLD OF EDUCATION

To

M/s Kalia Industries

B-27, Amanpuri

Najafgarh Road, Nangloi

New Delhi - 110041

Invoice No. : 007/2021-22

Invoice Date : 21/12/2021

Invoice for Consultancy Project

Particulars	Amount (Rs.)
Invoice for services rendered in relation to the consultancy project titled " Smart Furniture Designs and Detailing".	8,00,000
Net Amount Payable	8,00,000

(Rupees Eight Lakh Only)

Please make the payment of the invoice by NEFT/RTGS/IMPS as per Bank Detail:

Beneficiary Name : K.R. Mangalam University

Account No. : 091101000622

IFSC CODE : ICIC0000911

Bank : ICICI Bank Ltd.

Branch : Sohna Bus Stand, Gurgaon



PAN : AAJCS3143G

For K. R. Mangalam University

Registrar
K.R. Mangalam University
Sohna Road, Gurugram, (Haryana)

Authorised Signatory